

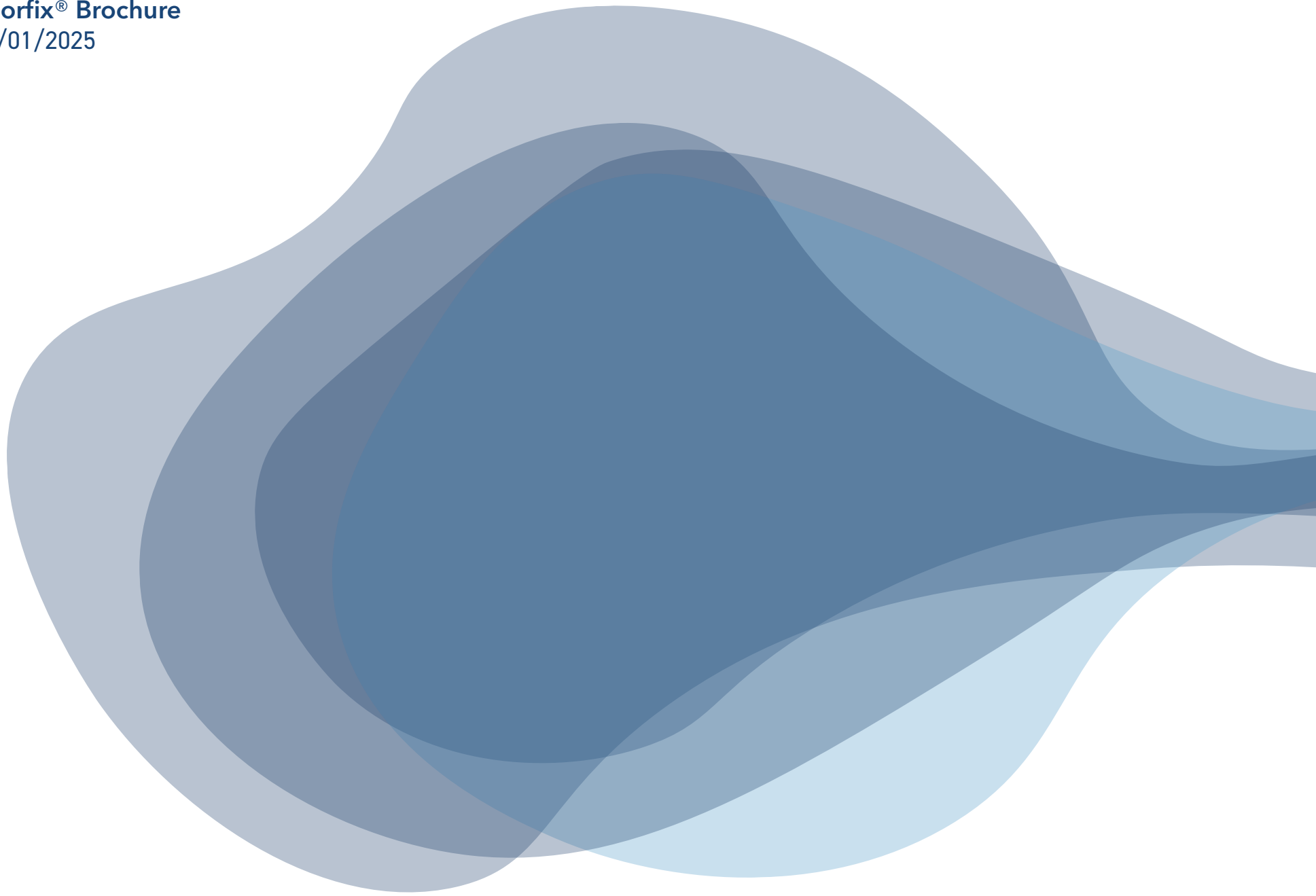

UP

**Sporfix<sup>®</sup>**  
Property of Ultrapharma BV



## Table of Contents

1. Introduction .....	4
2. Developed in cooperation with QV-Compliance A/S .....	5
3. Biological indicators .....	5
4. Available sizes .....	6
5. Sporfix instruction guide.....	9
6. Sporfix instruction guide (Mini).....	11
7. Available accessories .....	13

## 1. Introduction

The Sporfix® is a new concept used during validate-/revalidation of SIP processes in Bioreactors, Fermentors and other utilities. The Sporfix® is designed to perform in harsh environments which is where the SIP process is performed.

The biological spore strips that are used for this validation work have to be placed inside the pipework and be exposed to saturated steam. There is no standard solution for fixing the spore strip inside pipework. Across the world, everyone uses their method of fixing the biological indicator (BI) of which some likely disappear during the sterilization process. Another aspect of these handmade solutions is that they introduce inconsistencies leading to failures or contamination of the BI.

The handmade solutions, sometimes with materials with unknown quality and no traceability, can contaminate your whole process. The materials of the Sporfix comes with full traceability, material certificates and are FDA approved. So no more messing around with materials you really don't want in your process equipment.

The placement of the Sporfix® is secured by the solid metal wire. This wire and the thermocouple wire are taped together and brought inside the system through either a valve membrane or a sampling gasket. The distance between the Sporfix® and the outside connection can be any length. The Sporfix® is designed for single use to avoid direct handling of the BI's after studies.

When the sterilization cycle has ended the Sporfix® will be removed from the wire by cutting the wire. The biological indicator in the Sporfix® will after the thermal study, only be handled by the laboratory staff during incubation which will reduce the risk of cross-contamination considerably.

### Advantages of the Sporfix (Mini):

- It can securely hold both the Spore strip and Thermocouple wire.
- You can reach every spot in your system by using the push wire.
- No need for a close-by TC connection.
- Developed and validated in cooperation with QV-Compliance A/S.
- Now even available for 1/2" (ID 9,4 mm) piping.
- Standardized method.
- Single-use.

## 2. Developed in cooperation with QV-Compliance A/S

The Sporfix<sup>®</sup> is developed and validated by QV-Compliance A/S, an expert in validation and an end-user of validation products, in combination with Ultrapharma as an expert in product development for the Pharmaceutical and Biotech industries. Our Sporfix<sup>®</sup> meets high demands and is extensively tested in real world applications.

QV-Compliance A/S has executed the validation of the Sporfix<sup>®</sup>, which means that this method is proven and captured in work instructions.

## 3. Biological indicators

Ultrapharma and QV-Compliance A/S are recommending to use the Spordex<sup>®</sup> Biological Indicator Strips, in combination with our Sporfix<sup>®</sup>.

Spordex<sup>®</sup> Biological Indicator Strips are used to validate and re-qualify ethylene oxide (EO), dry heat or saturated steam sterilization. Each strip is individually packaged and in a glassine envelope and inoculated with bacterial spores, either *Bacillus atrophaeus* (BA) (formerly *Bacillus subtilis* var. *niger*) for ethylene oxide (EO) and dry heat sterilization or *Geobacillus stearothermophilus* (GS) for saturated steam sterilization.



#### 4. Available sizes

The Sporfix® is available in three sizes; normal size, small size & extra small size. The small version is for TC size ½ inch and the normal version is for TC size ¾ inch and up. For even smaller ½" tubing area's we have developed an extra small (short) Sporfix®. This one is only 46 mm long and can hold a blue envelope Sporestrip which is only 25 mm long. This will open up lots of new opportunities to constantly measure SIP validation sterility tasks.

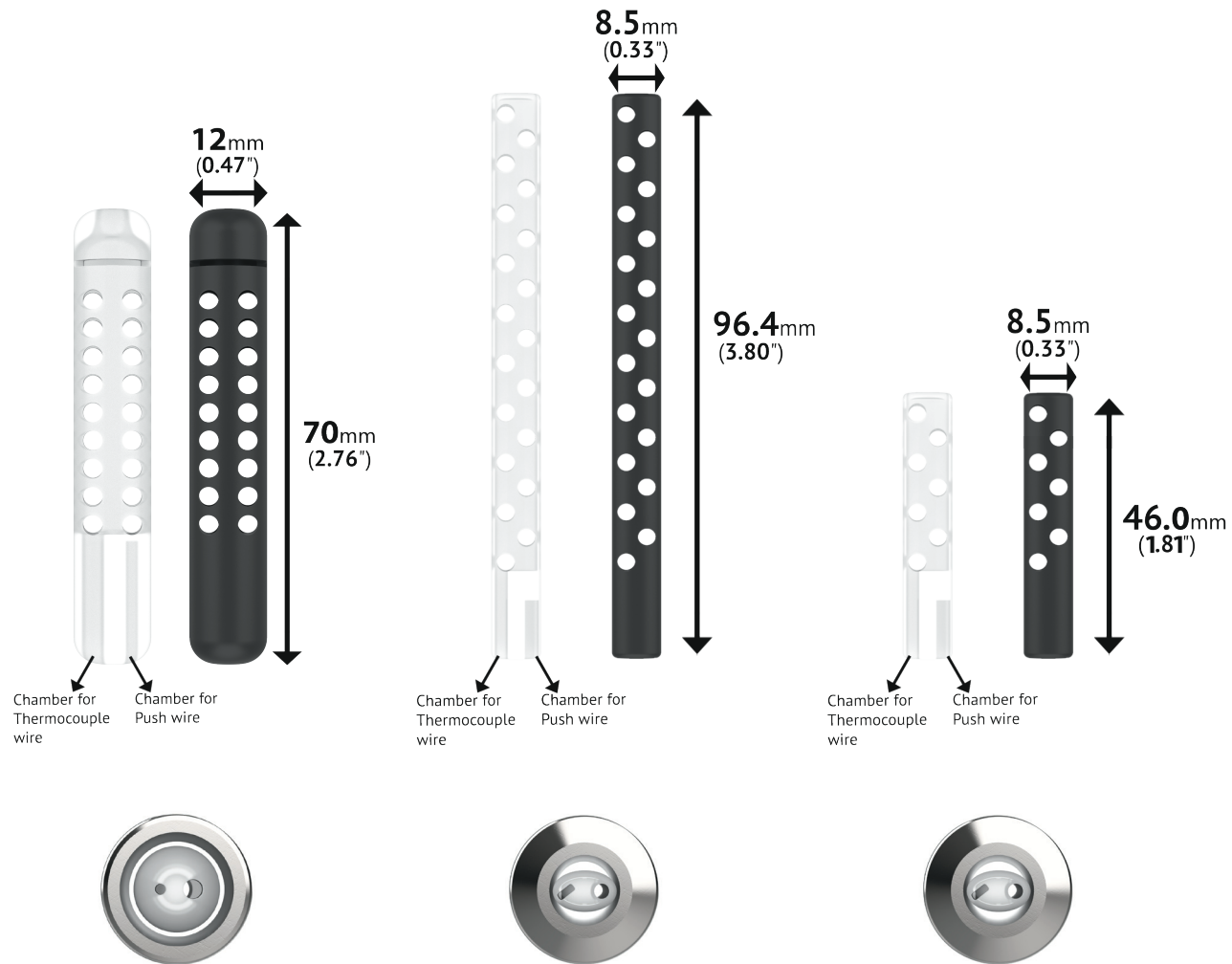

## EPDM (CMD-1073)

EPDM, Ethylene Propylene Diene Monomer, is an “M” class synthetic rubber elastomer. The M class comprises elastomers having a saturated chain of the polyethylene type (the M deriving from the more correct term polymethylene) EPDM is one of the most popular and versatile polymer in sealing applications. It remains flexible in a wide range of temperatures, this is why it has excellent sealing capacities.

Chemically, EPDM has good resistance to animal oils, vegetable oils, ozone, strong chemicals, and oxidizing chemicals. Do not use EPDM gaskets for mineral oils, solvents, or aromatic hydrocarbons.

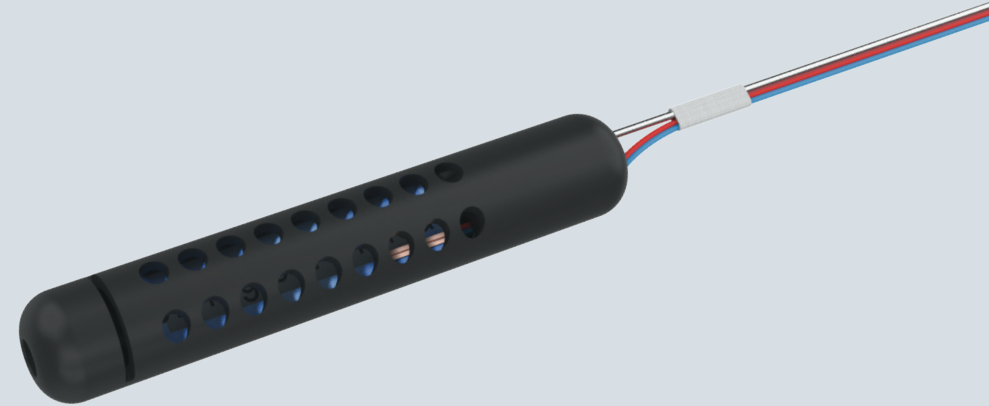

### General Advice

SIP ----- Good short exposure  
 CIP ----- Good  
 Minerals Oils & Grease ----- Poor  
 WFI ----- Good  
 Sterilization ----- Excellent  
 Stam sterilization ----- Good

### Working temperature and pressure

The working range of CMD-1073 is -40°C to 150°C short 150°C. The gaskets can be used up to 10 Bar at 20°C.

Typical general characteristics	Inspection Method	Requirements	Value
Hardness (Shore A)	ASTM D2240/05	70±5	73
Tensile strength (MPa)	ASTM D412/06	≥ 10.0	12.02
Elongation (%)	ASTM D412/06	≥ 200	241
Compression set, 22hrs @ 150°C	ASTM D395/03B	10%	13%
Specific Gravity (g/cm <sup>3</sup> )			1.175

Platinum Silicone (CMD-1086)

Silicone is widely used in pharmaceutical applications for two major reasons. First, and foremost, is safety. Silicone does not contain plasticizers or other additives that could leach into a drug product and cause toxicological issues. Second, silicone is highly flexible and tear-resistant, making it a good choice for sealing fluids in downstream processes.

In order to make silicone gaskets there are two cure system options with silicones, however, that produces materials with different characteristics, whose impact should be considered before selection. Silicone materials may be cured using free radical (peroxide) or addition (platinum) cure mechanisms.

Platinum-cured and peroxide-cured silicone gaskets can both be made to USP Class VI and other industry specifications, but a platinum-cured gasket has a higher purity and lower leachability than peroxide-cured silicone.

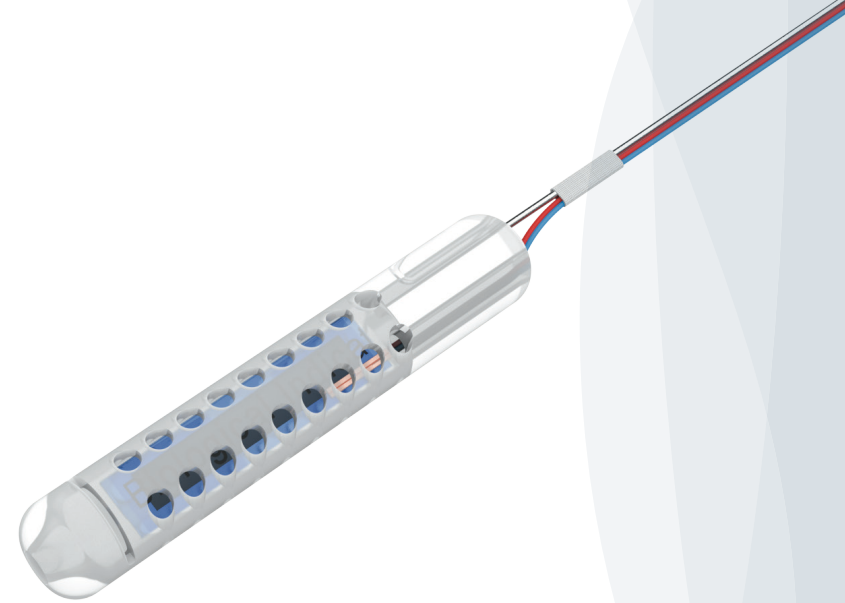

**General Advice**

SIP -----Very good  
CIP ----- Very good  
Minerals Oils & Grease ----- Bad  
WFI ----- Good  
Sterilization ----- Excellent  
Steam Sterilization----- Excellent

**Working temperature and pressure**  
The working range of platinum silicone (CMD-1072) is -60°C to 200°C. Platinum Silicone gaskets can be used up to 10 Bar at 20°C.

Typical general characteristics	Inspection Method	Requirements	Value
Hardness (Shore A)	DIN53505	70±5	70
Tensile strength (N/mm <sup>2</sup> )	DIN53504 S1	≥ 6,00	9
Elongation (%)	DIN53504 S1	≥ 350 %	650 %
Specific Gravity			1.19 g/cm <sup>3</sup>
Compression set (22h@175°C, DIN ISO 815-B)			63
Appearance			Transparent

5. Sporfix instruction guide

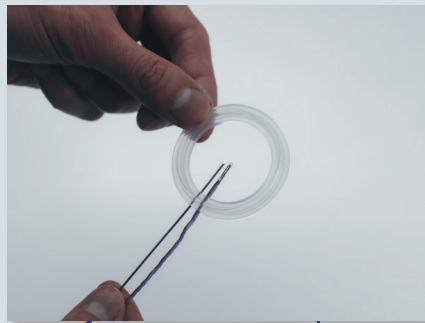

Sporfix® Brochure  
31/01/2025

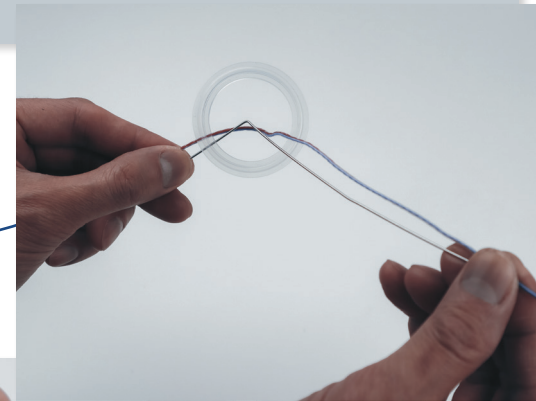
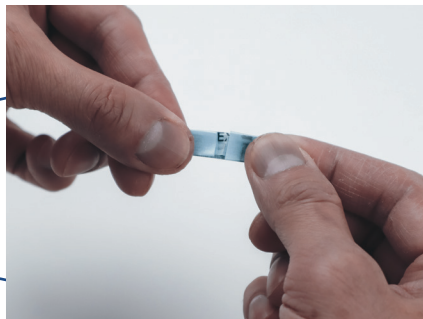
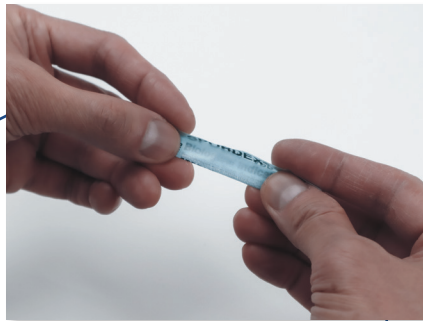

6. Sporfix instruction guide (Mini)

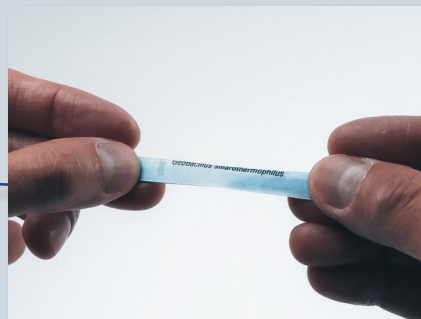
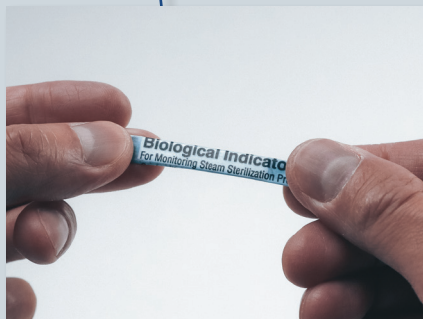
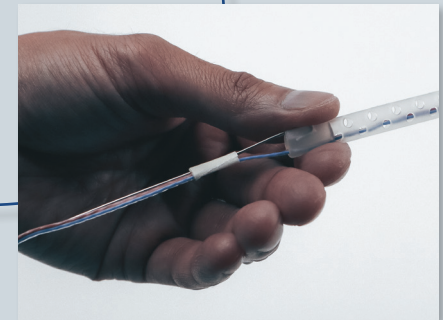
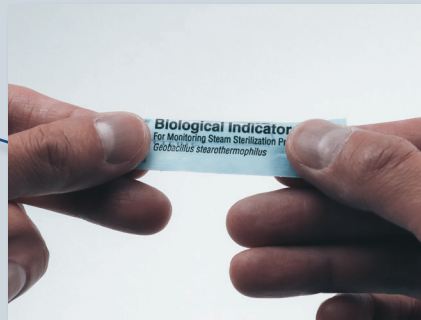
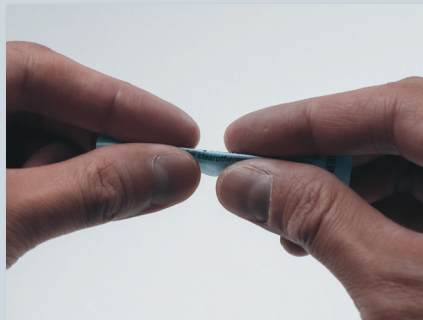

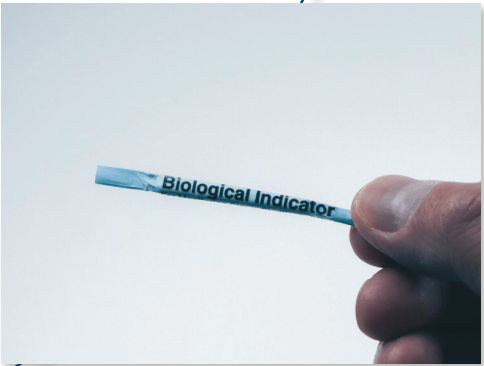

## 7. Available accessories

### Sporfix® Tool

This accessory is useful for multiple purposes. It's used to bend the end of the push wire in a perfectly sized small hook, that fits inside the Sporfix® for the fixation. Also the pointy, thin area of the tool acts as a slide to insert the Spore strip correctly.



### Sporfix® Push wire

A stainless steel wire (Ø1mm) for the fixation of the Sporfix® at the desired spot in your system. For optional thermal mapping at the Biological Indicator Strip, a Thermocouple wire can be fixed to the Push wire.

Standard length of 1 meter, different lengths available on request.

### Sampling gaskets

The Sporfix is usually mounted with a 1,00 mm stainless steel wire and a thermocouple. The wire thermocouple can be one of the most common brands Kaye, Ellab or Industry-Lives, as long as they are not (a lot) bigger than ø2,00 mm in diameter.

These two wires are inside the pipe and need to be brought to the outside, as the thermocouple needs to be connected to a datalogger. This has to be done in a correct way so the thermocouple does not get damaged.

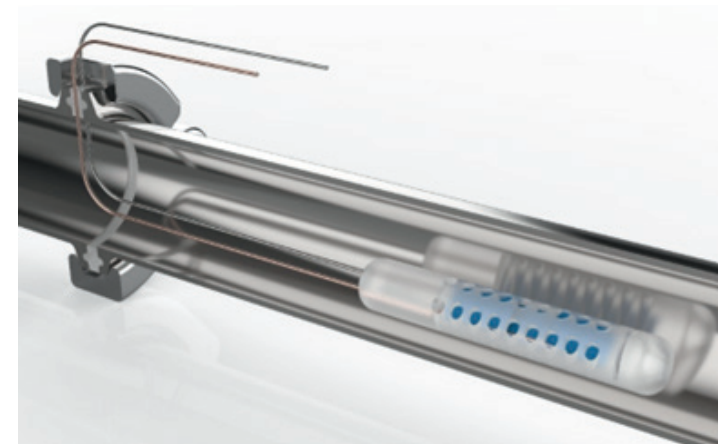

Below is a table of Sampling gaskets that we have available specially for the Sporfix® program. With the gaskets we offer slotted clamps to accommodate a safe passage for the wires. Sampling gaskets are available in EPDM and Silicone.

**Sporfix® Sampling Gaskets**

Platinum Silicone	CMD-1012
UP-G-TH-050-S-1-SPORFIX	1/2" OD TUBE PLATINUM SILICONE THERMOCOUPLE TC GASKET, 1 PORT + SPORFIX PORT, DIMENSION: 22X10.8
UP-G-TH-075-S-1-SPORFIX	3/4" OD TUBE PLATINUM SILICONE THERMOCOUPLE TC GASKET, 1 PORT+ SPORFIX PORT, DIMENSION: 22X16.2
UP-G-TH-100-S-1-SPORFIX	1" OD TUBE PLATINUM SILICONE THERMOCOUPLE TC GASKET, 1 PORT + SPORFIX PORT, DIMENSION: 50.5X22.5
UP-G-TH-150-S-1-SPORFIX	1.1/2" OD TUBE PLATINUM SILICONE THERMOCOUPLE TC GASKET, 1 PORT + SPORFIX PORT, DIMENSION: 50.5X35.3
UP-G-TH-200-S-1-SPORFIX	2" OD TUBE PLATINUM SILICONE THERMOCOUPLE TC GASKET, 1 PORT + SPORFIX PORT, DIMENSION: 64X47.8
UP-G-TH-250-S-1-SPORFIX	2.1/2" OD TUBE PLATINUM SILICONE THERMOCOUPLE TC GASKET, 1 PORT + SPORFIX PORT, DIMENSION: 77.5X61
UP-G-TH-300-S-1-SPORFIX	3" OD TUBE PLATINUM SILICONE THERMOCOUPLE TC GASKET, 1 PORT + SPORFIX PORT, DIMENSION: 91X73.5
UP-G-TH-400-S-1-SPORFIX	4" OD TUBE PLATINUM SILICONE THERMOCOUPLE TC GASKET, 1 PORT + SPORFIX PORT, DIMENSION: 119X98.2

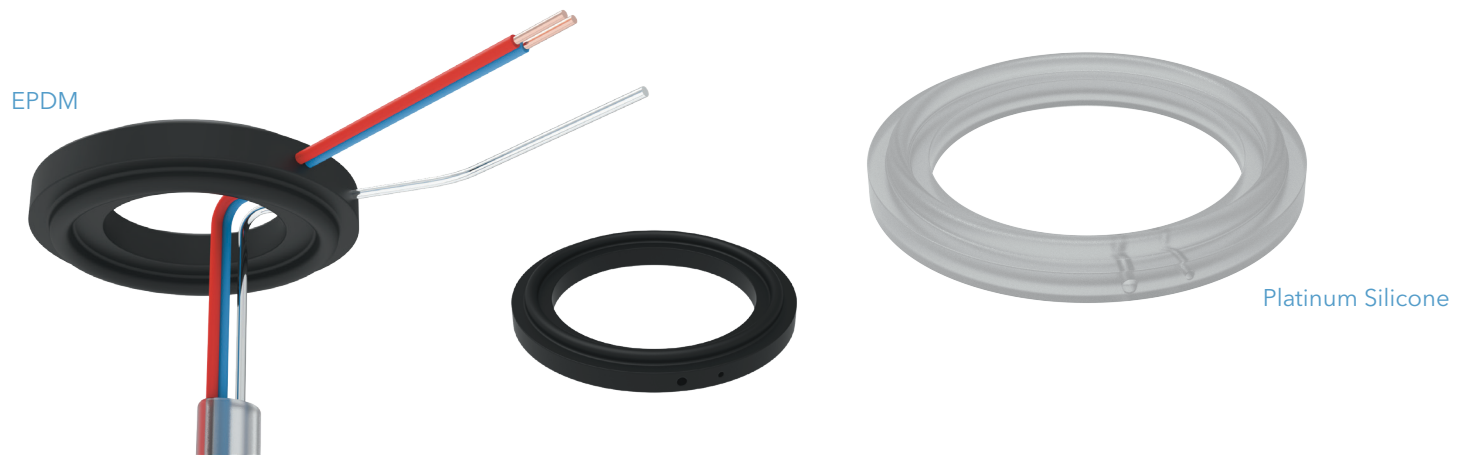

EPDM	CMD-1004
UP-G-TH-050-E-1-SPORFIX	1/2" OD TUBE EPDM THERMOCOUPLE TC GASKET, 1 PORT + SPORFIX PORT, DIMENSION: 22X10.8
UP-G-TH-075-E-1-SPORFIX	3/4" OD TUBE EPDM THERMOCOUPLE TC GASKET, 1 PORT+ SPORFIX PORT, DIMENSION: 22X16.2
UP-G-TH-100-E-1-SPORFIX	1" OD TUBE EPDM THERMOCOUPLE TC GASKET, 1 PORT + SPORFIX PORT, DIMENSION: 50.5X22.5
UP-G-TH-150-E-1-SPORFIX	1.1/2" OD TUBE EPDM THERMOCOUPLE TC GASKET, 1 PORT + SPORFIX PORT, DIMENSION: 50.5X35.3
UP-G-TH-200-E-1-SPORFIX	2" OD TUBE EPDM THERMOCOUPLE TC GASKET, 1 PORT + SPORFIX PORT, DIMENSION: 64X47.8
UP-G-TH-250-E-1-SPORFIX	2.1/2" OD TUBE EPDM THERMOCOUPLE TC GASKET, 1 PORT + SPORFIX PORT, DIMENSION: 77.5X61
UP-G-TH-300-E-1-SPORFIX	3" OD TUBE EPDM THERMOCOUPLE TC GASKET, 1 PORT + SPORFIX PORT, DIMENSION: 91X73.5
UP-G-TH-400-E-1-SPORFIX	4" OD TUBE EPDM THERMOCOUPLE TC GASKET, 1 PORT + SPORFIX PORT, DIMENSION: 119X98.2

Example 1" Sporfix® Gasket  
(DIN32676-C /ASME BPE)

Sampling Gaskets for DIN32676-A and series-B are available on request.

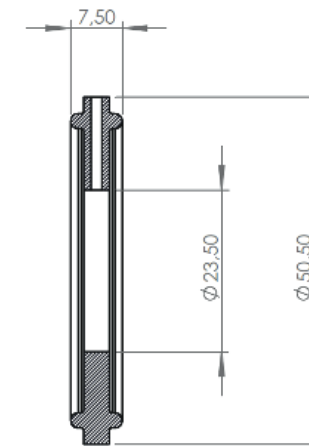
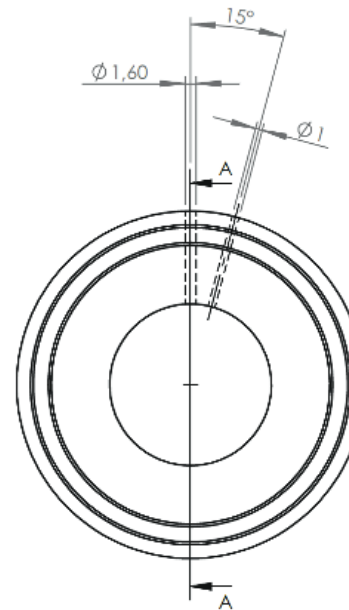

SECTION A-A

Sampling Clamps



Introducing Ultrapharma's Allport Sampling Clamp: a versatile, half-open clamp adaptable for any number of ports, eliminating the need for multiple clamps. Paired with redesigned gaskets featuring repositioned ports, it offers enhanced workspace and simplified assembly. This design ensures optimal port placement for accessibility and minimal obstruction, addressing common issues like difficult alignment and wingnuts obstructing probes.

Article Number	Article	SIZE
UP-G-TH-050/075-N-BLUE	RESISTOR RING FOR ALLPORT MINI (PACK OF 5 PCS)	25 mm
CL-TH-050/075-ALLPORT	CLAMP FOR 1/2" & 3/4" TC SPORFIX CONNECTIONS, WITH WIDE POINT ENTRY SLOTS FOR EASY ASSEMBLY	25 mm
CL-TH-100/150-ALLPORT	CLAMP FOR 1" & 1.5" TC SPORFIX CONNECTIONS, WITH WIDE ENTRY SLOTS FOR EASY ASSEMBLY	50,5 mm
CL-TH-200-1P	CLAMP FOR 2" TC SPORFIX CONNECTION	64 mm
CL-TH-250-2P	CLAMP FOR 2.5" TC SPORFIX CONNECTION	77,5 mm
CL-TH-300-2P	CLAMP FOR 3" TC SPORFIX CONNECTION	91 mm
CL-TH-400-2P	CLAMP FOR 4" TC SPORFIX CONNECTION	119 mm



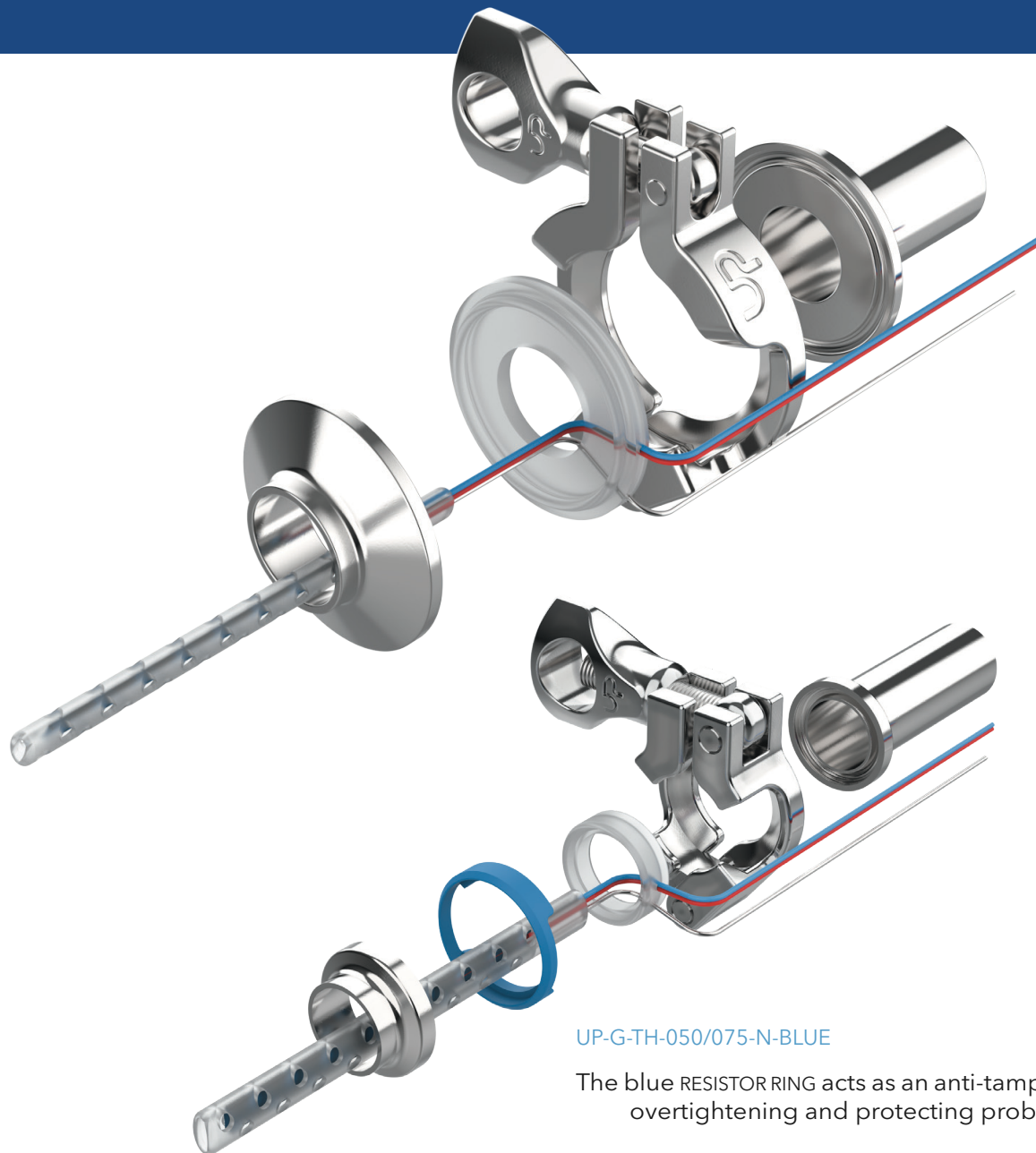

Shown on the left in exploded view, the Allport Clamp and Mini Allport Clamp feature a half-open design for flexible sampling configurations. The Mini version offers the same functionality in a compact form, perfect for tight spaces.

UP-G-TH-050/075-N-BLUE

The blue RESISTOR RING acts as an anti-tamper device, preventing overtightening and protecting probes from damage.

## Weir Diaphragms

In practice there are more valves in a system than Tri-Clamp connections. A valve can also be used to feed the wires through to the outside. We introduced a full line of weir-diaphragms from GEMU, SAUNDERS and ITT with pre-drilled holes. One bigger hole for the thermocouple and one smaller hole for the pushing wire. The diaphragm can be mounted in two directions so the Sporfix® can be pointed left or right, depending on the steam direction. Caution: both wires may never pass the weir inside the valve. The valve must be operational during validation hence it can potentially damage the thermocouple wire.

On the right you see the illustration of a mounted Sporfix® through a typical weir diaphragm. Weir Diaphragms with feedthrough holes for validation are available in EPDM only. A full listing of all configurations is shown below in the Diaphragm table.

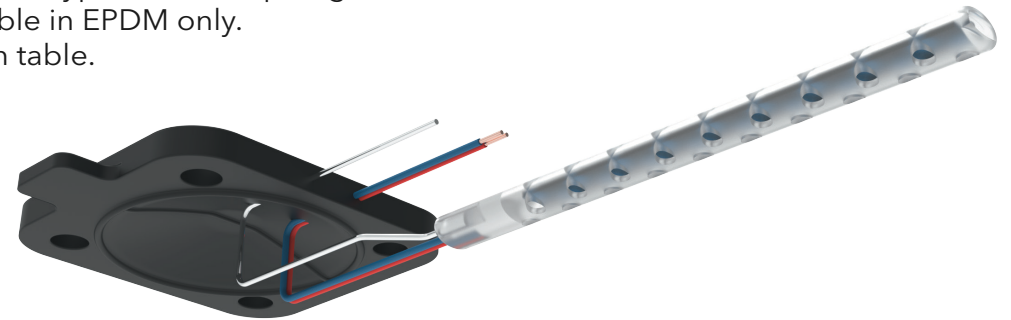

EPDM Weir Diaphragms

GEMU	Description
UP-G-DD03-GEB-SPORFIX	EPDM 1/2" (DN8) WEIR DIAPHRAGM W/ TWO HOLES 1.6MM + 1.0MM FOR SPORFIX MOUNT (GEMU)
UP-G-DD07-GET-SPORFIX	EPDM 3/4" (DN10/15) WEIR DIAPHRAGM W/ TWO HOLES 1.6MM + 1.0MM FOR SPORFIX MOUNT (GEMU)
UP-G-DD10-GET-SPORFIX	EPDM 1" (DN25) WEIR DIAPHRAGM W/ TWO HOLES 1.6MM + 1.0MM FOR SPORFIX MOUNT (GEMU)
UP-G-DD15-GET-SPORFIX	EPDM 1.5" (DN40) WEIR DIAPHRAGM W/ TWO HOLES 1.6MM + 1.0MM FOR SPORFIX MOUNT (GEMU)
UP-G-DD20-GET-SPORFIX	EPDM 2" (DN50) WEIR DIAPHRAGM W/ TWO HOLES 1.6MM + 1.0MM FOR SPORFIX MOUNT (GEMU)
UP-G-DD30-GET-SPORFIX	EPDM 2.5" + 3" (DN65/80) WEIR DIAPHRAGM W/ TWO HOLES 1.6MM + 1.0MM FOR SPORFIX MOUNT (GEMU)
UP-G-DD40-GET-SPORFIX	EPDM 4" (DN100) WEIR DIAPHRAGM W/ TWO HOLES 1.6MM + 1.0MM FOR SPORFIX MOUNT (GEMU)

SAUNDERS	
UP-G-DD03-SEB-SPORFIX	EPDM 1/2" (DN8) WEIR DIAPHRAGM W/ TWO HOLES 1.6MM + 1.0MM FOR SPORFIX MOUNT (SAUNDERS)
UP-G-DD03-SET-SPORFIX	EPDM 1/2" (DN8) WEIR DIAPHRAGM W/ TWO HOLES 1.6MM + 1.0MM FOR SPORFIX MOUNT (SAUNDERS)
UP-G-DD05-SEB-SPORFIX	EPDM 1/2" (DN15) WEIR DIAPHRAGM W/ TWO HOLES 1.6MM + 1.0MM FOR SPORFIX MOUNT (SAUNDERS)
UP-G-DD05-SET-SPORFIX	EPDM 1/2" (DN15) WEIR DIAPHRAGM W/ TWO HOLES 1.6MM + 1.0MM FOR SPORFIX MOUNT (SAUNDERS)
UP-G-DD07-SEB-SPORFIX	EPDM 3/4" (DN20) WEIR DIAPHRAGM W/ TWO HOLES 1.6MM + 1.0MM FOR SPORFIX MOUNT(SAUNDERS)
UP-G-DD07-SET-SPORFIX	EPDM 3/4" (DN20) WEIR DIAPHRAGM W/ TWO HOLES 1.6MM + 1.0MM FOR SPORFIX MOUNT(SAUNDERS)
UP-G-DD10-SET-SPORFIX	EPDM 1" (DN25) WEIR DIAPHRAGM W/ TWO HOLES 1.6MM + 1.0MM FOR SPORFIX MOUNT (SAUNDERS)
UP-G-DD15-SET-SPORFIX	EPDM 1.5" (DN40) WEIR DIAPHRAGM W/ TWO HOLES 1.6MM + 1.0MM FOR SPORFIX MOUNT(SAUNDERS)
UP-G-DD20-SET-SPORFIX	EPDM 2" (DN50) WEIR DIAPHRAGM W/ TWO HOLES 1.6MM + 1.0MM FOR SPORFIX MOUNT (SAUNDERS)
UP-G-DD25-SET-SPORFIX	EPDM 2.5" (DN65) WEIR DIAPHRAGM W/ TWO HOLES 1.6MM + 1.0MM FOR SPORFIX MOUNT(SAUNDERS)
UP-G-DD30-SET-SPORFIX	EPDM 3" (DN80) WEIR DIAPHRAGM W/ TWO HOLES 1.6MM + 1.0MM FOR SPORFIX MOUNT (SAUNDERS)
UP-G-DD40-SET-SPORFIX	EPDM 4" (DN100) WEIR DIAPHRAGM W/ TWO HOLES 1.6MM + 1.0MM FOR SPORFIX MOUNT (SAUNDERS)

ITT	
UP-G-DD03-IET-SPORFIX	EPDM 1/2" (DN10) WEIR DIAPHRAGM W/ TWO HOLES 1.6MM + 1.0MM FOR SPORFIX MOUNT (ITT)
UP-G-DD05-IET-SPORFIX	EPDM 1/2" (DN15) WEIR DIAPHRAGM W/ TWO HOLES 1.6MM + 1.0MM FOR SPORFIX MOUNT (ITT)
UP-G-DD07-IET-SPORFIX	EPDM 3/4" (DN20) WEIR DIAPHRAGM W/ TWO HOLES 1.6MM + 1.0MM FOR SPORFIX MOUNT(ITT)
UP-G-DD10-IET-SPORFIX	EPDM 1" (DN25) WEIR DIAPHRAGM W/ TWO HOLES 1.6MM + 1.0MM FOR SPORFIX MOUNT (ITT)
UP-G-DD15-IET-SPORFIX	EPDM 1.5" (DN40) WEIR DIAPHRAGM W/ TWO HOLES 1.6MM + 1.0MM FOR SPORFIX MOUNT(ITT)
UP-G-DD20-IET-SPORFIX	EPDM 2" (DN50) WEIR DIAPHRAGM W/ TWO HOLES 1.6MM + 1.0MM FOR SPORFIX MOUNT (ITT)
UP-G-DD30-IET-SPORFIX	EPDM 3" (DN80) WEIR DIAPHRAGM W/ TWO HOLES 1.6MM + 1.0MM FOR SPORFIX MOUNT(ITT)
UP-G-DD40-IET-SPORFIX	EPDM 4" (DN100) WEIR DIAPHRAGM W/ TWO HOLES 1.6MM + 1.0MM FOR SPORFIX MOUNT(ITT)

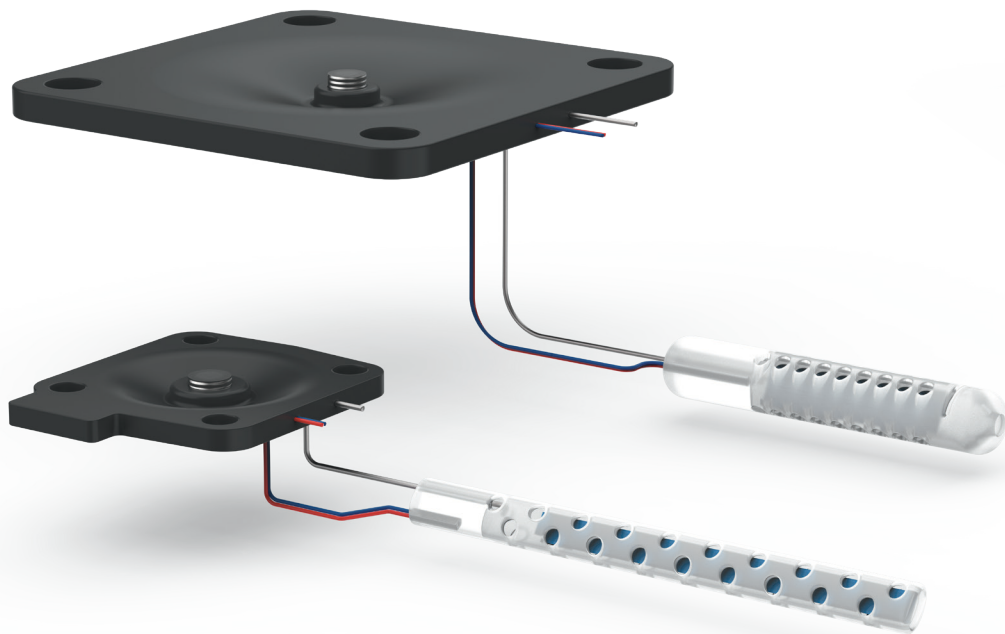

Biological Sporfix Holder (NEW)

DN	Article Number	Material	Size mm
1/2"	UP-G-BSSH-050-XS-SPX-MKII	PLATINUM SILICONE	Ø 8 X 65
1/2"	UP-G-BSSH-050-XS-E-MKII	EPDM (PEROXIDE)	Ø 8 X 65
1/2"	UP-G-BSSH-050-SPX-MKII	PLATINUM SILICONE	Ø 8 x 112.5
1/2"	UP-G-BSSH-050-E-MKII	EPDM (PEROXIDE)	Ø 8 x 112.5
3/4"	UP-G-BSSH-075-SPX	PLATINUM SILICONE	Ø 12 x 70
3/4"	UP-G-BSSH-075-E	EPDM (PEROXIDE)	Ø 12 x 70

316 SS Wire Coiled

Product	Article Number	Material	Size
1 Meter Wire Pack of 5	UP-G-BSW-1000-5	316 Stainless Steel	Ø1,00 mm

Sporfix Tool

Product	Article Number	Material	Size
Sporfix Tool	UP-G-BST-075-SS	304SS	12 mm



 **Ultrapharma**<sup>bv</sup>

De Droogmakerij 12

1851 LX Heiloo

The Netherlands

+31 856 200 900

[info@ultrapharma.com](mailto:info@ultrapharma.com)

